



PlayStation

NTSC U/C

PlayStation™

DISRUPTOR™



SLUS-00224
96001



WARNING: READ BEFORE USING YOUR PLAYSTATION™ GAME CONSOLE.

A very small percentage of individuals may experience epileptic seizures when exposed to certain light patterns or flashing lights. Exposure to certain patterns or backgrounds on a television screen or while playing video games, including games played on the PlayStation game console, may induce an epileptic seizure in these individuals. Certain conditions may induce previously undetected epileptic symptoms even in persons who have no history of prior seizures or epilepsy. If you, or anyone in your family, has an epileptic condition, consult your physician prior to playing. If you experience any of the following symptoms while playing a video game – dizziness, altered vision, eye or muscle twitches, loss of awareness, disorientation, any involuntary movement, or convulsions – IMMEDIATELY discontinue use and consult your physician before resuming play.

WARNING TO OWNERS OF PROJECTION TELEVISIONS:

Do not connect your PlayStation game console to a projection TV without first consulting the user manual for your projection TV, unless it is of the LCD type. Otherwise, it may permanently damage your TV screen.

HANDLING YOUR PLAYSTATION™ DISC:

- This compact disc is intended for use only with the PlayStation™ game console.
- Do not bend it, crush it or submerge it in liquids
- Do not leave it in direct sunlight or near a radiator or other source of heat.
- Be sure to take an occasional rest break during extended play.
- Keep this compact disc clean. Always hold the disc by the edges and keep it in its protective case when not in use. Clean the disc with a lint-free, soft, dry cloth, wiping in straight lines from center to outer edge. Never use solvents or abrasive cleaners.

Table of Contents

Startup Information	3
Controllers.....	4
Introduction	5
Starting the Game.....	6
Reading The Screen	8
Map Screen.....	10
Weapons of the LightStormer	11
Using Psionic Disciplines.....	13
Missions.....	15
Gameplay Notes and Passwords.....	19
Credits.....	20
Warranty	21



Startup Information

Set up your PlayStation™ game console according to the instructions in its Instruction Manual. Make sure the power is off before inserting or removing a compact disc. Insert the Disruptor™ disc and close the CD door. Insert game controllers and turn on the PlayStation™ game console. Follow on-screen instructions to start a game.

Console

Top View

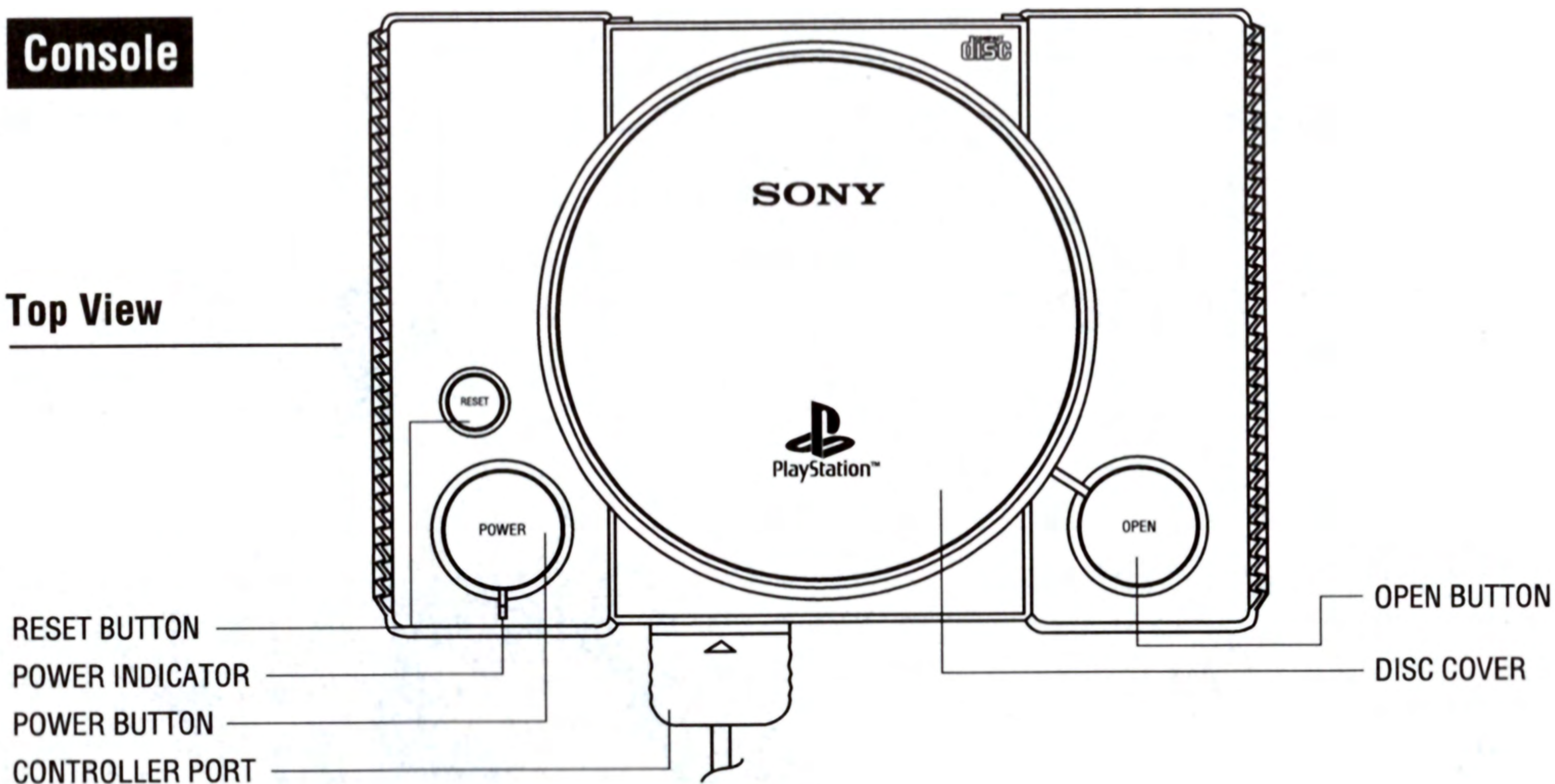

Front View

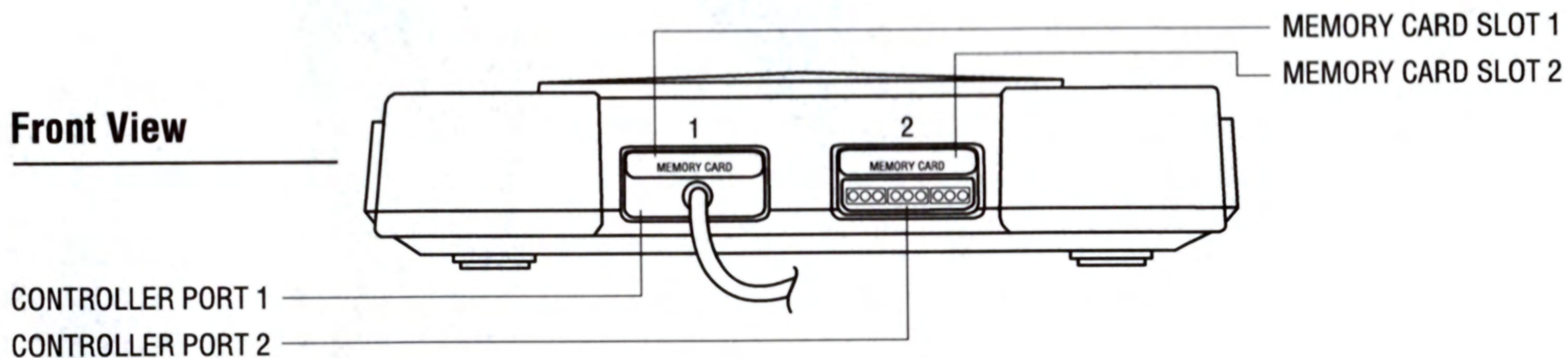

With mastery comes true power. Listed below are the default settings for the controls of Disruptor.

Directional Keys

- ↑ Walk forward
- ↓ Walk backward
- Turn to the right
- ← Turn to the left
- × **Button** Shoot gun
- **Button** Activate psionic discipline
- **Button** Jump
- △ **Button** Open Doors/Throw Switches

L1 Choose weapon (use the D-Pad to make selection). **ADVANCED FEATURE:** Click L1 twice to quick-switch to the last weapon used.

R1 Choose psionic discipline (use the D-Pad to make selection). **ADVANCED FEATURE:** Click R1 twice to quick-switch to the last psionic used.

L2 and R2 Sidestep to the left or right

TIP: Use the sidestep to dodge enemy missile attacks.

Start Button Pause the game.

Select Button Bring up map.

Controller

Front View

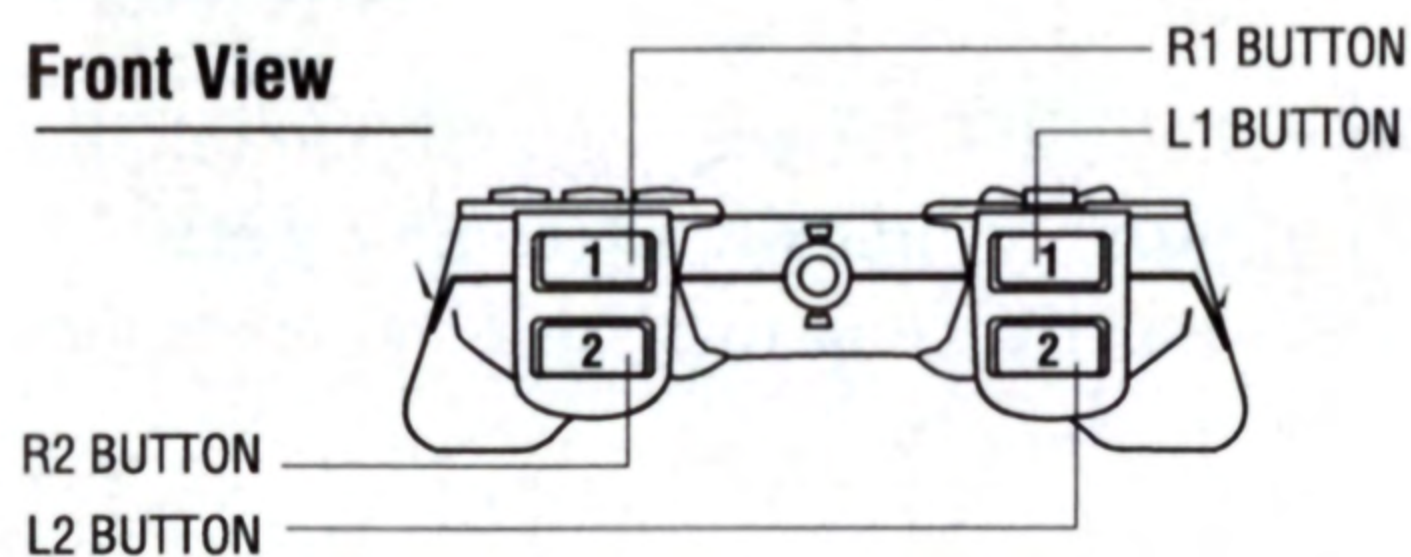

Top View

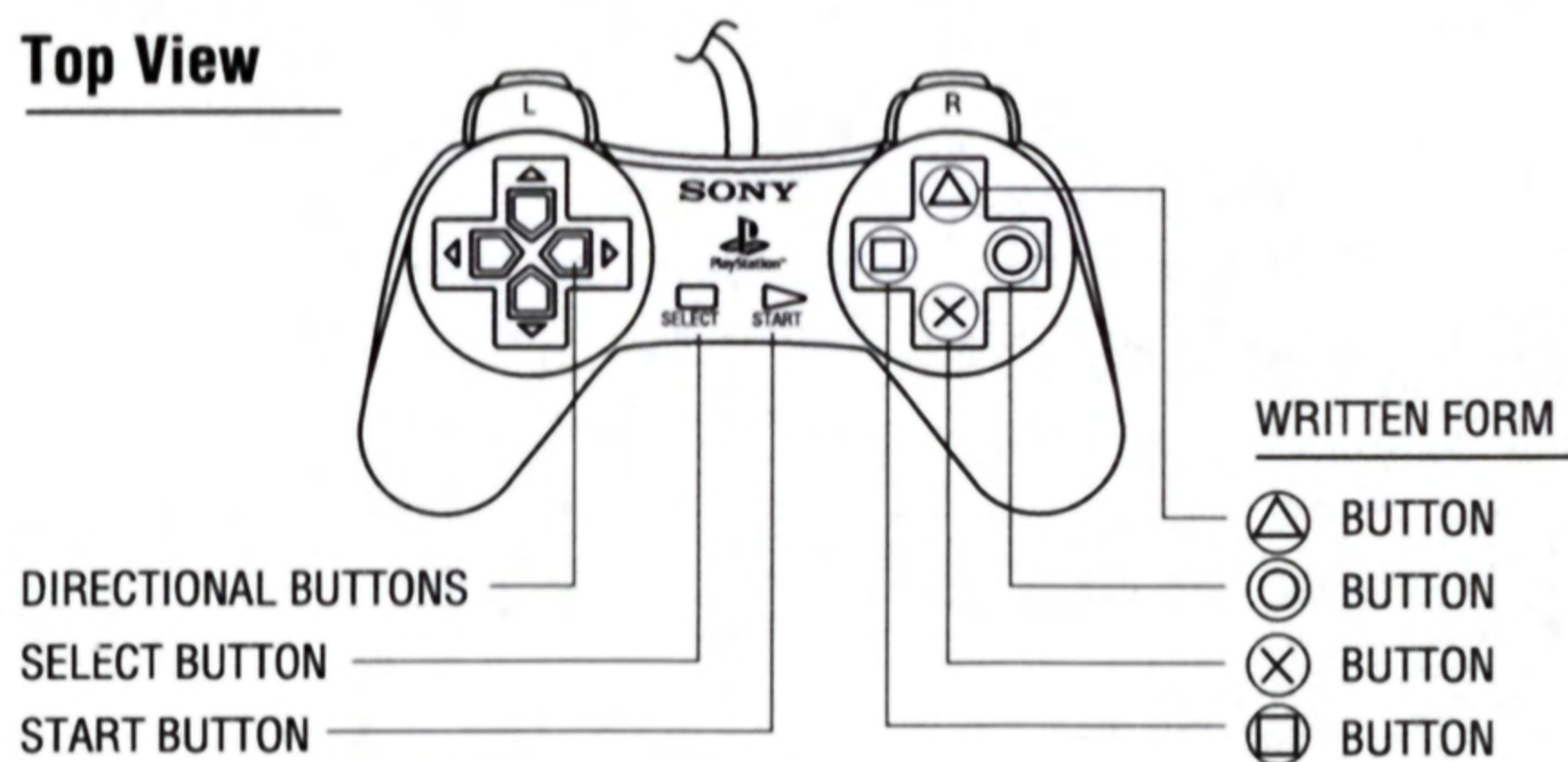

A Cold Day In The Far Future

You have been accepted into the legendary LightStormer Corps, an Earth-based organization that has brought peace to the solar system through force. As a new recruit to this elite cadre, you must learn the ropes of survival in a hostile universe. Soon you'll become proficient in the use of a wide selection of firearms and close-quarter battle tactics. If you don't, this will be a very short enlistment.

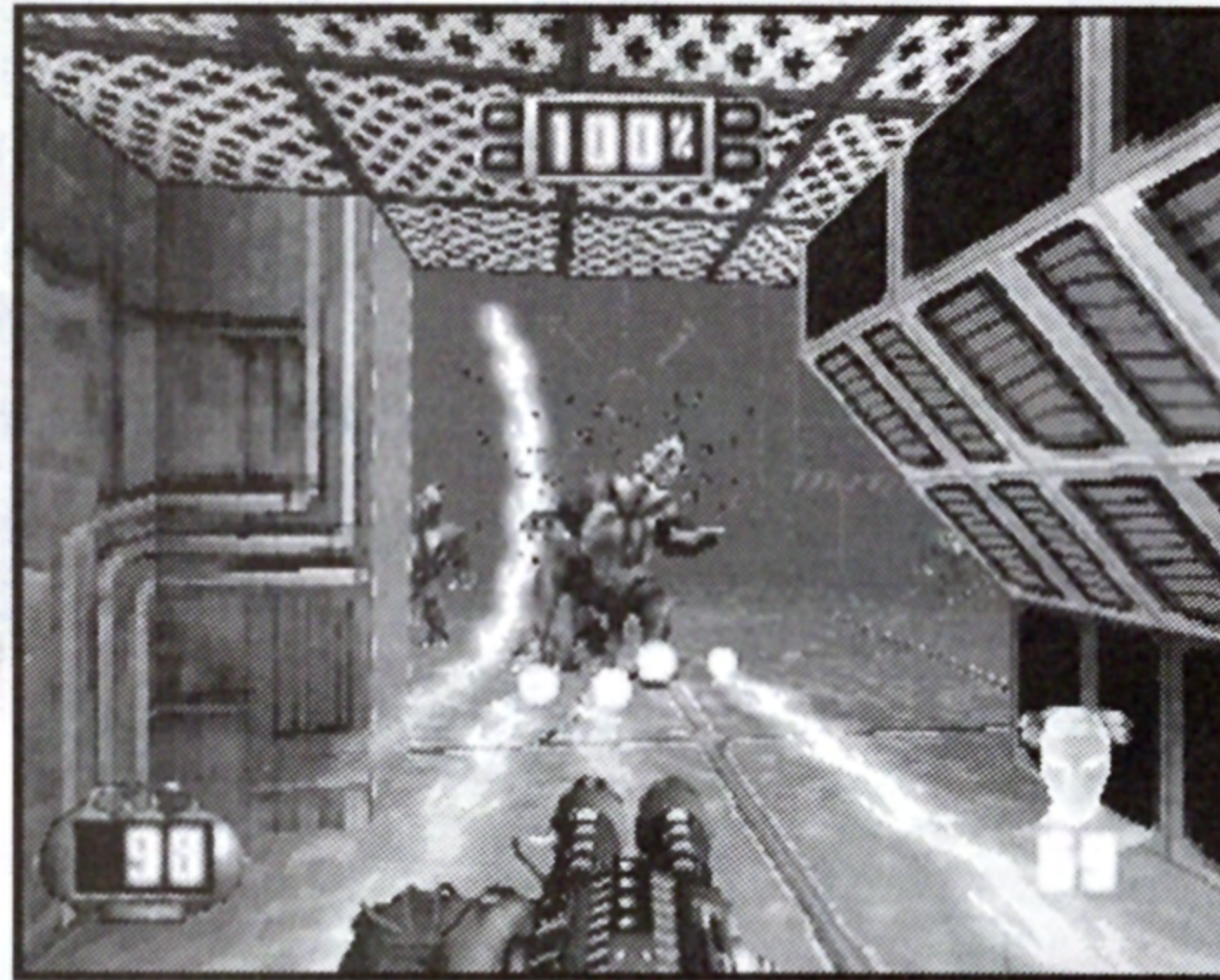

Your superiors have also entrusted you with a neurological implant that enhances your natural mental abilities to deadly heights. You must master several psionic disciplines in order to unleash awesome mental attacks as well as healing physical damage you have sustained. Gain experience in these psionic techniques to use the force of your mind to crush your enemies.

All the while a series of new worlds and adventures await you. Intrigue and deception are a part of the expanding universe; miss one clue and for all your vaunted weapons and powers you will still be shipped home in a pine box.

Pay attention to the details, look both ways and remember the credo of the LightStormers:

**THINK FAST, SHOOT FAST,
KICK ASS!**

Use the Practice Mode to hone your battle skills before beginning a new game. Check out the multiple button configurations in the Controller Options screen in the Main Menu. Play with each setting to determine which one has the most natural feel for your gaming style.

Starting the Game

Set the disc in the disc holder, turn the PlayStation™ console ON, and close the disc cover.

Press the Start Button to bypass the opening sequence (but if it's your first time, we recommend you watch it). As a note in general, you should watch all of the video interludes to gain valuable mission information. You never know what will turn up between missions...

Listed below are the selections available from the Main Menu screen. Use the Directional Button to move the highlight to the choice you desire and press the × button to select it. The Main Menu selections include:

Practice Mode - Explore Missions 1 through 5 to earn valuable gameplay experience.



New Game - Begin your tour of duty as a LightStormer. Progress can be saved (using your Memory Card) or you may play the game using passwords given to you when you complete each level.

Load Game - This option allows you to download a previously saved game from your Memory Card. Saved games played in hard mode appear in red. Follow the instructions in the sub-menu to continue from the last mission you completed. By pushing the Directional Button left and right, you can also re-play previous missions.



Password-This feature allows you to enter the special coded password given to you when you complete a mission. Use this option if you don't have a memory card.

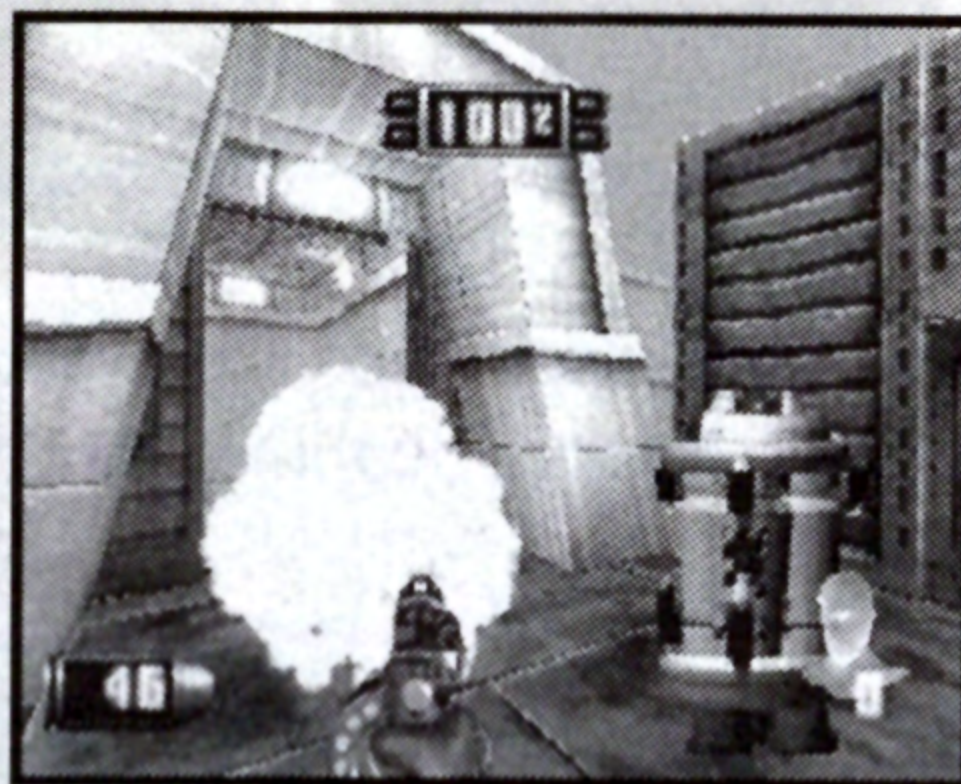

Controller Options- There are four pre-set configurations for the controller. Find out which combination works best with your style of game playing.

Other Options- Adjust the tunes, sound FX and camera sway to suit your taste.

Credits- The teams involved in creating this epic are listed here. If the names look familiar, then you were probably at the Post Office recently.

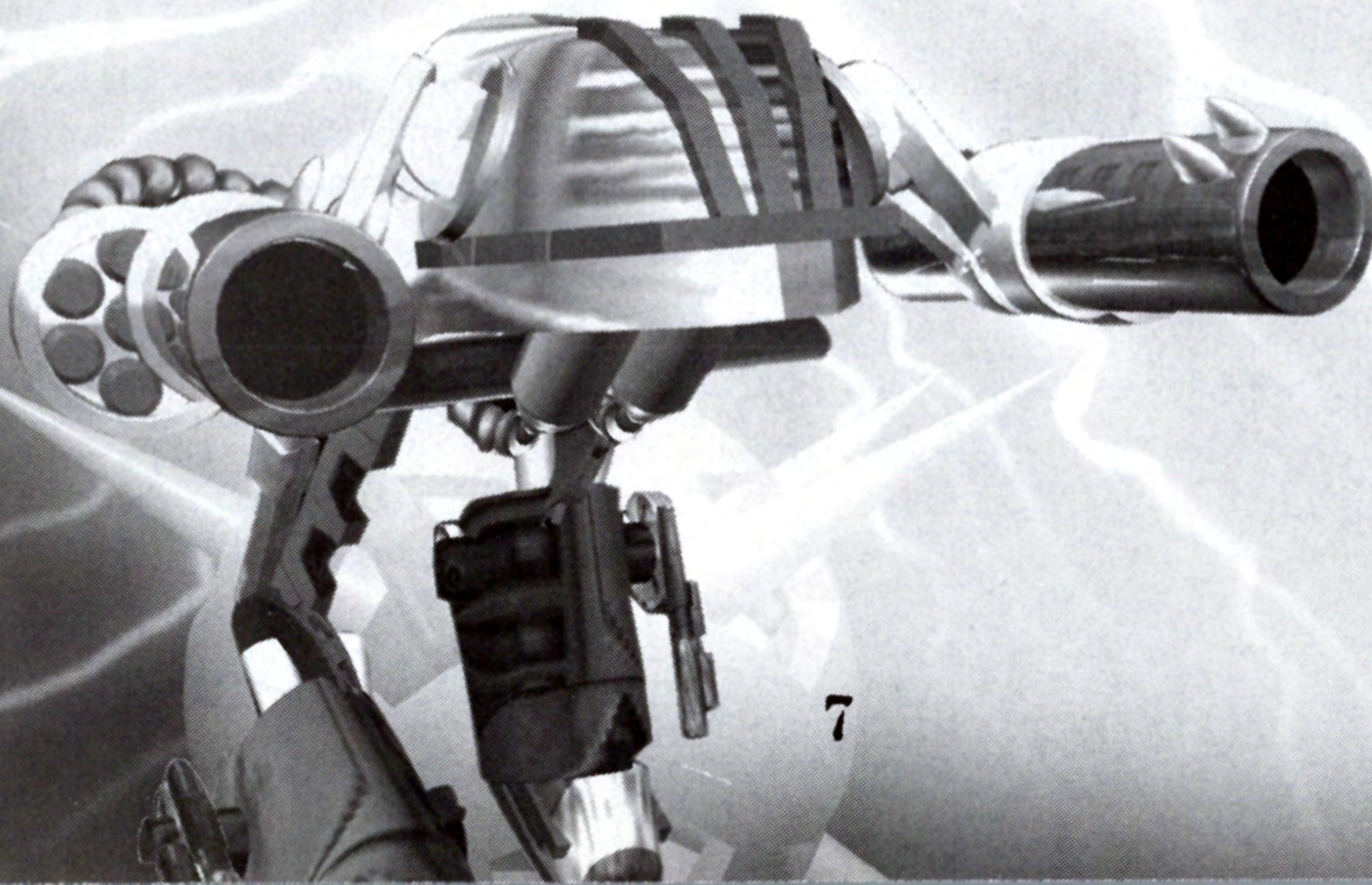

Reading The Screen

Your status is shown on-screen in the following areas:

HEALTH

The percentage of your character's health is shown here. This meter can read up to 200% if you find the endorphin boosts hidden in the game. If this meter ever reaches 0% you are dead.

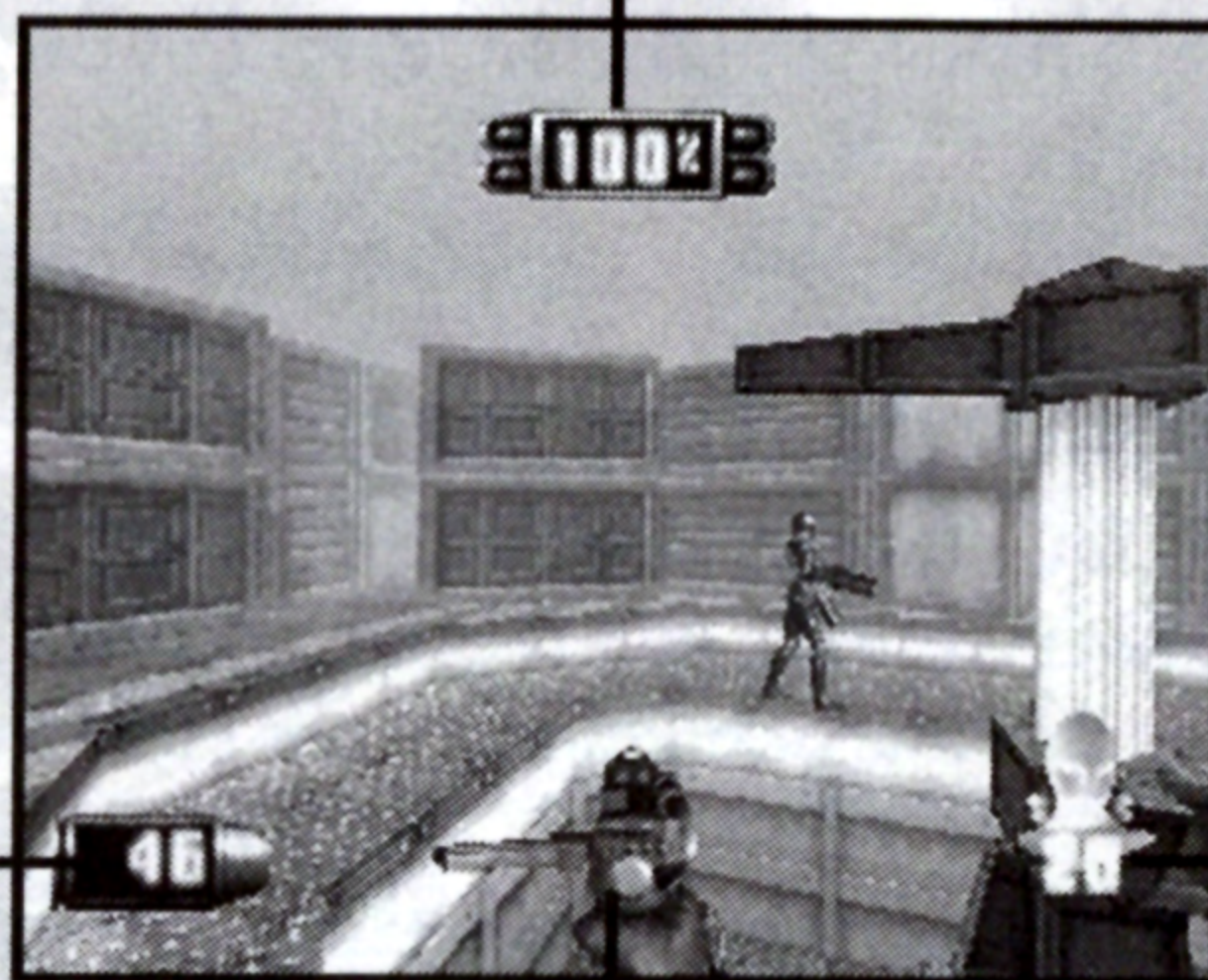

CURRENT AMMO COUNT

This icon matches the weapon that is in use. The number in the icon represents the number of rounds remaining. If you have special ammo, the numbers appear in red and indicate the amount of special ammo remaining.

CURRENT WEAPON

The weapon you are carrying is generally shown at the bottom of the screen.

PSIONIC POWER

(Sigh-on-ik). This meter shows your current mental energy. There are small icons that appear next to this icon that inform you of the currently selected mental discipline. (See Using Psionics section of the manual.)

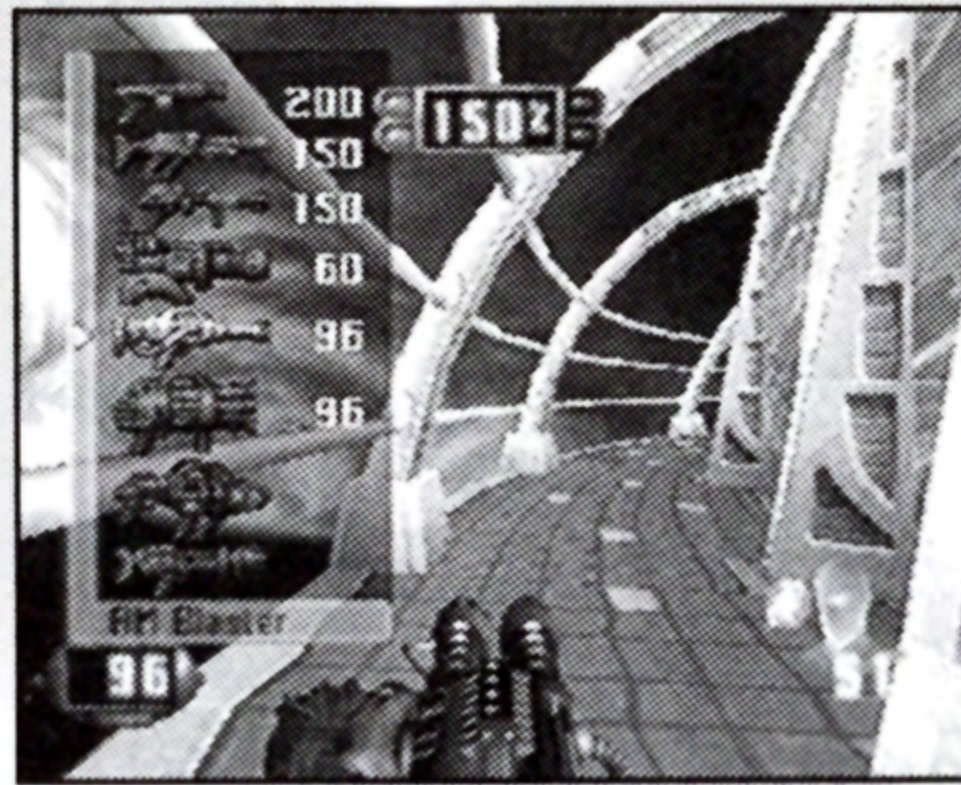

Weapon Inventory

Press L1 to bring up the Weapon Inventory. Use the Directional Button to scroll through your selection of firearms.

The total ammo (including special ammo) appears to the right of each weapon. Remember that some weapons share ammunition.



Psionic Inventory

As you progress in your missions you will be given numerous psionic powers to learn and use. Press R1 to bring up the Psionic Inventory. Use the Directional Button to scroll through your selection of powers.

NOTE: Changing weapons and psionics does not stop the action of the game! You should find a secure location to change weapons or psionics.

ADVANCED TIP: When you pause to change weapons, keep in mind which weapon and psionic is available by quick-switch (See CONTROLS). That way you can stay right in the thick of the action!

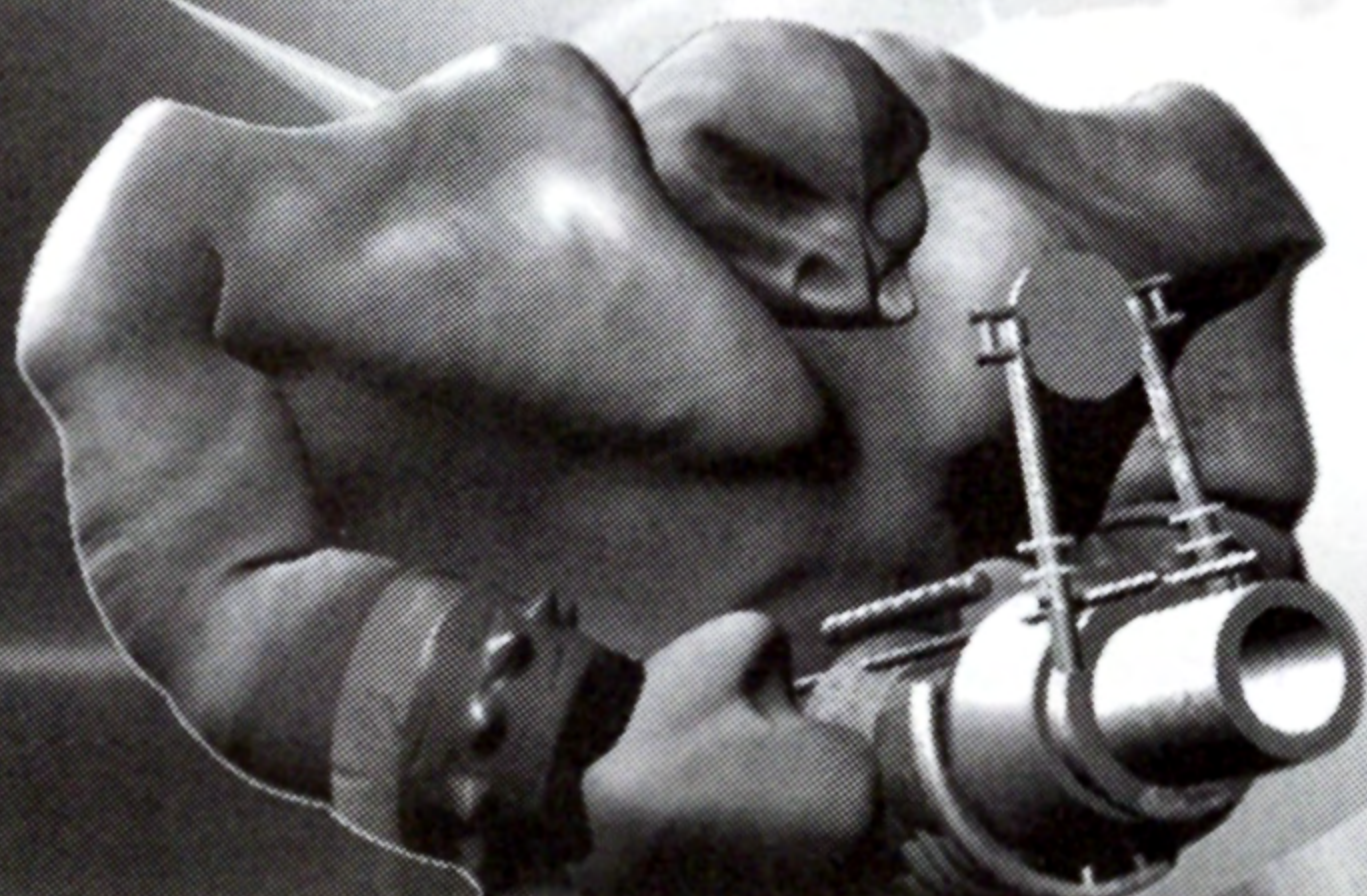

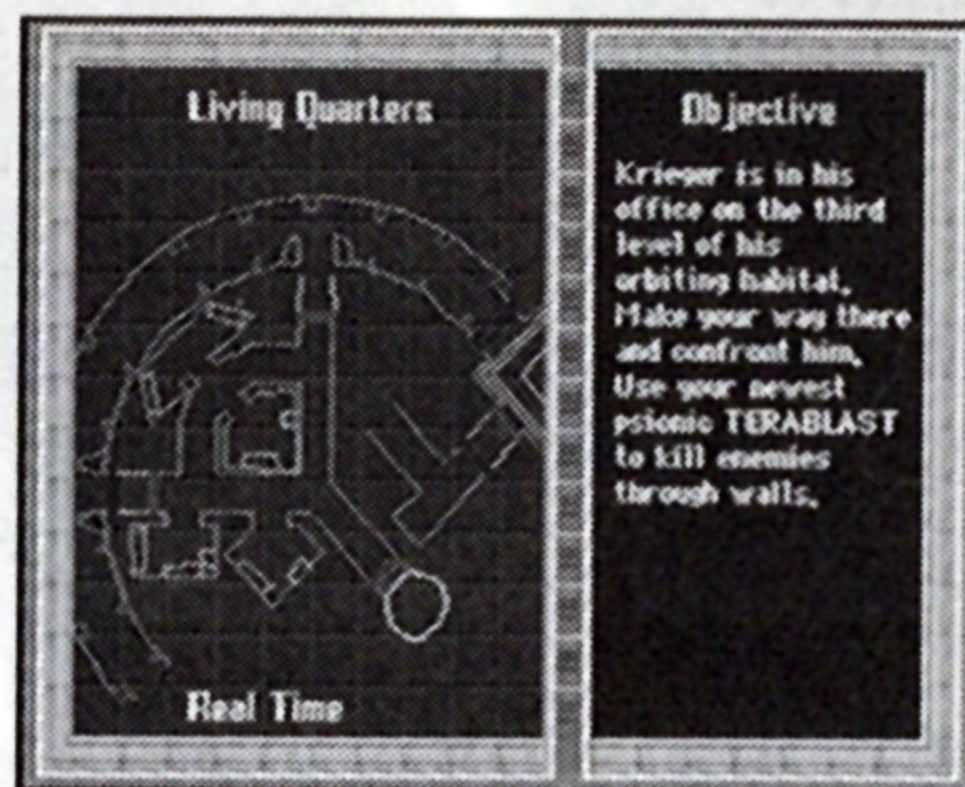

Map Screen

Press the Select Button during the gameplay to access your Automapper. When you enter the Automap, your location appears as an arrow in the center of the screen. You can navigate and play the game as usual in this mode. To exit 'real time' mode, press the L1 or R1 button. When real time mode is OFF, the game is paused and you can view the entire Automap by scrolling with the Directional Button. Press L1 or R1 button again to turn real time mode back ON.

Press SELECT again to return to normal gameplay.

Mission Complete

When you finish a mission, the Mission Complete screen shows your Kills and Completion percentages. The Kills number shows the percentage of actual enemies you eliminated in the level. The Completion percentage is based on the following factors: eliminating enemies, exploring the entire level and retrieving all ammunition.

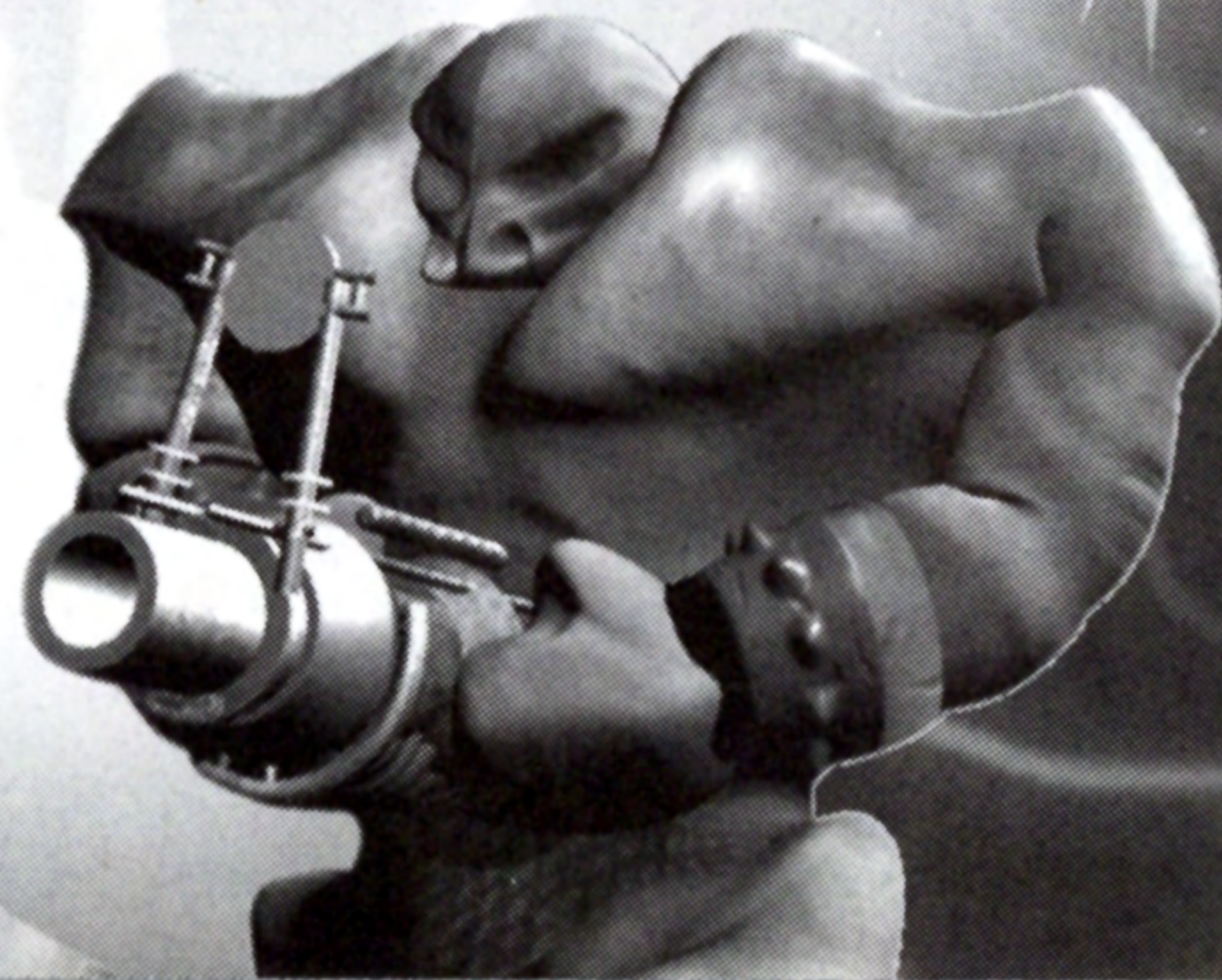

Weapons of the LightStormer

Big guns are not a euphemism for anything. You need them to carry out your missions, period. This being the case, the bigger they come, the more likely you are to survive. Upgrades can be found throughout the game.

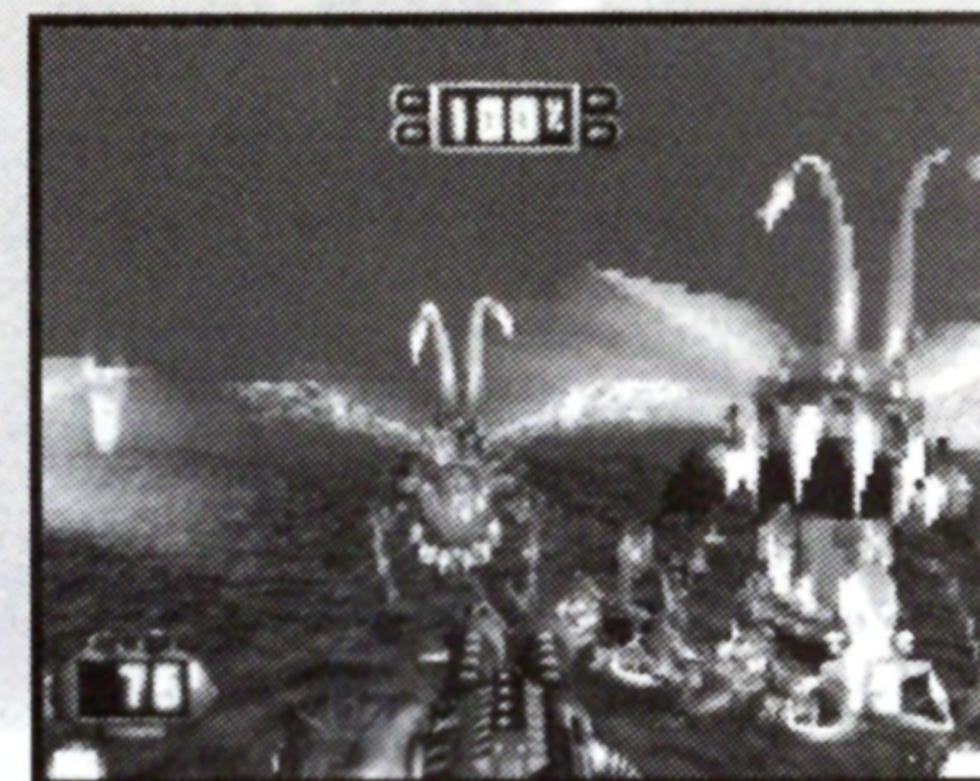

18mm Pistol

Part of the standard issue gear. Not as much firepower as some of the other weapons, but treated as a dear old friend by experienced LightStormers who rely upon its instantaneous shot and classic reliability.

18mm Automatic

Recent improvements in technology have allowed the standard 18mm to be permanently upgraded to a faster refire rate. Those who have tried it say they'll never go back.



Phase Rifle

The powerful laser bursts are extremely effective against organic enemies. While scarcity prohibits the general issue of **High Frequency Ammo**, those in the know rave about its rapid recharge rate and ability to penetrate multiple targets.

Additional Weapons: A PRIMER

As a LightStormer you will travel to the farthest reaches of the galaxy to face a variety of enemies. Occasionally, you may come across weapons that, while not included in the standard issue gear, may prove useful in combat. These armaments are reputed to include:

AM Blaster

A favorite among space-pirates, these shotgun-type weapons emit a powerful spray especially effective in close quarters. Many of these models are equipped to fire double bursts when the trigger is held down longer than one second.



Lock-On Cannon

This weapon's slow-moving projectiles are deceiving: Once locked on to a target, they never miss and deliver intense damage. A special aiming reticle assists targeting: green indicates no enemies present, amber indicates enemies present but out of range, and red means fire away! While scarce, specially crafted Binary Lock-On Ammo is capable of neutralizing multiple targets with a single shot.

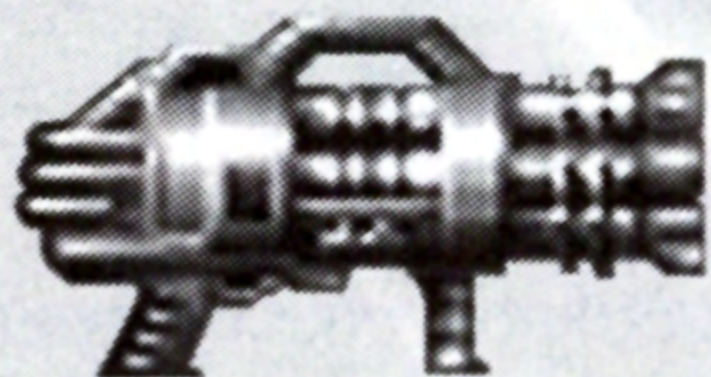

AM Cyclone

Incorporating the same ammunition as the AM Blaster, this deadly device fires five explosive rounds at once. The damage from this weapon is huge, so use in close quarters is not recommended.

Phase Repeater

Popular among certain terrorist organizations, these modified Phase Rifles dish out three times the damage, but do go through the ammo.



Unauthorized Weapons

Lightstormer authorities have confirmed the existence of the following two weapon types. They are used primarily in the outlaw zones of the Solar System and are not officially sanctioned for use by LightStormers.



Plasma Lance



Zodiac

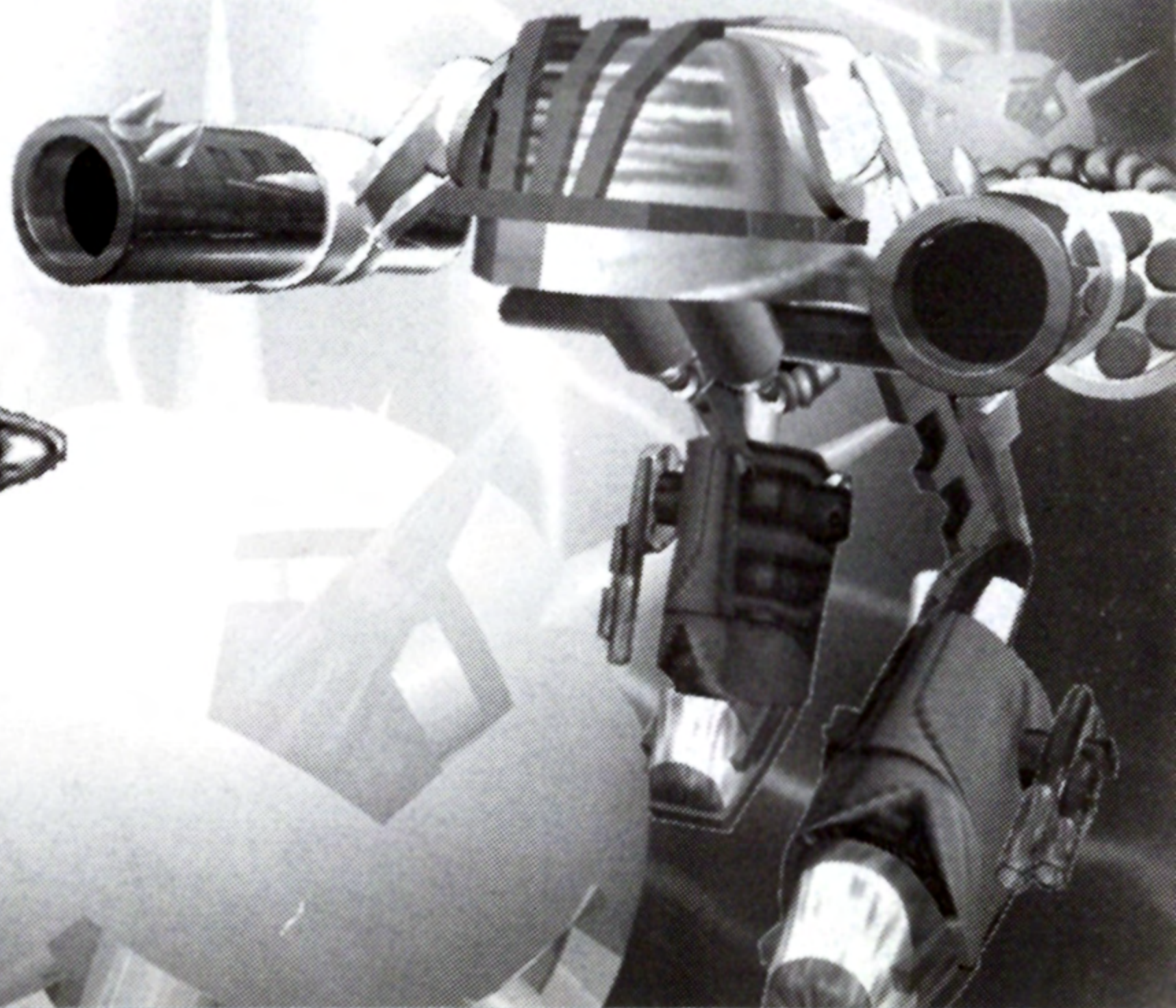

Using Psionic Disciplines

One of the qualifying factors of your becoming a LightStormer is your ability to accept a neurosurgical implant that has opened the door to your mind's hidden powers. This implant, working in conjunction with the skills of Psionics, allows you to unleash incredible damage to your enemies through concentration and will-power. (This force is measured in psionic points and is seen on the bottom right section of the game screen.)

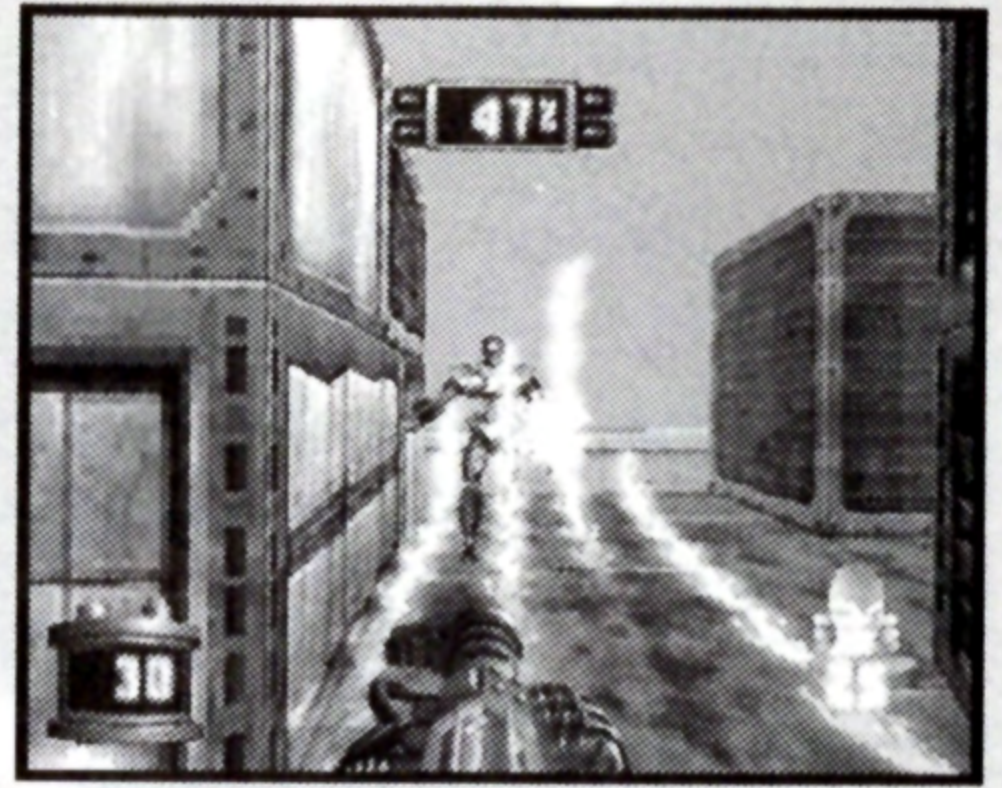

These offensive and defensive disciplines make up another aspect of your LightStormer training. Even if you are unarmed, you will be able to use your mind as a deadly weapon. With experience, your progression through each set of missions adds to your growth not only as a gun-wielding soldier, but as a psychic warrior as well.

Shock

Deadly at close range, this attack costs 5 psionic points.

Drain

What appears to be a weak weapon is vital for you to master in the early missions. When the Drain projectile hits an enemy a small blue orb of energy appears. You have 8 seconds to grab this orb (before it disappears) to add its energy back to your Psionic strength. The number of Drain orbs is proportionate to the strength of the enemy. Skilled LightStormers often use Drain in conjunction with a physical weapon for maximum effect.

Heal

Use 20 psionic points to add 20% back to your health.





Shield

Protect yourself from enemies and hostile terrain by using this discipline. The shield will remain in effect as long as you hold the button down (and have a supply of Psi. points).

Blast

This is a costly (25 psionic points), but awesome weapon which allows you to destroy multiple targets with one detonation. Press the button to launch the projectile then steer it by using the Directional Button until it reaches the optimum location for detonation. Press the button again to unleash the blast. All enemies within a six meter radius from the blast will be destroyed. Blue energy orbs will appear after the explosion for you to pick up for additional psionic points.

Terablast

This special upgrade to the Psionic Blast allows its damage to pass through walls unaffected.

NOTE: If you no longer have enough psionic points to use the currently selected psionic discipline, you will be automatically switched to Drain in order to gain your points back. If your psionic points reach 0, they will recharge to 1 after a short time.

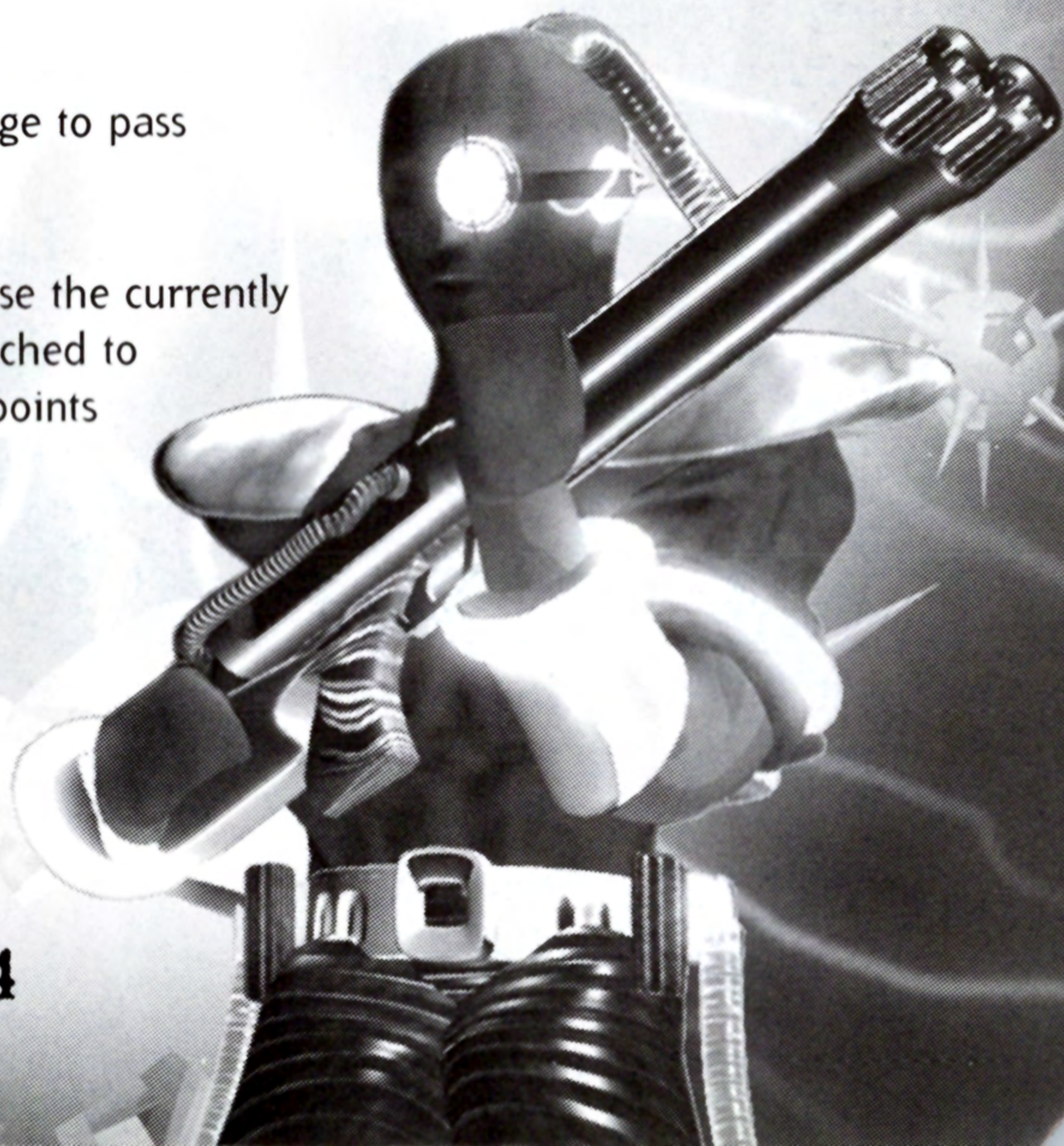

The Missions

The first three missions you undergo are training exercises. Your goal in these is one of survival. Just because they are designated training exercises, however, does not mean your death is any less painful. The LightStormers have built their traditions upon the valor of the victorious, not the memories of the dead.

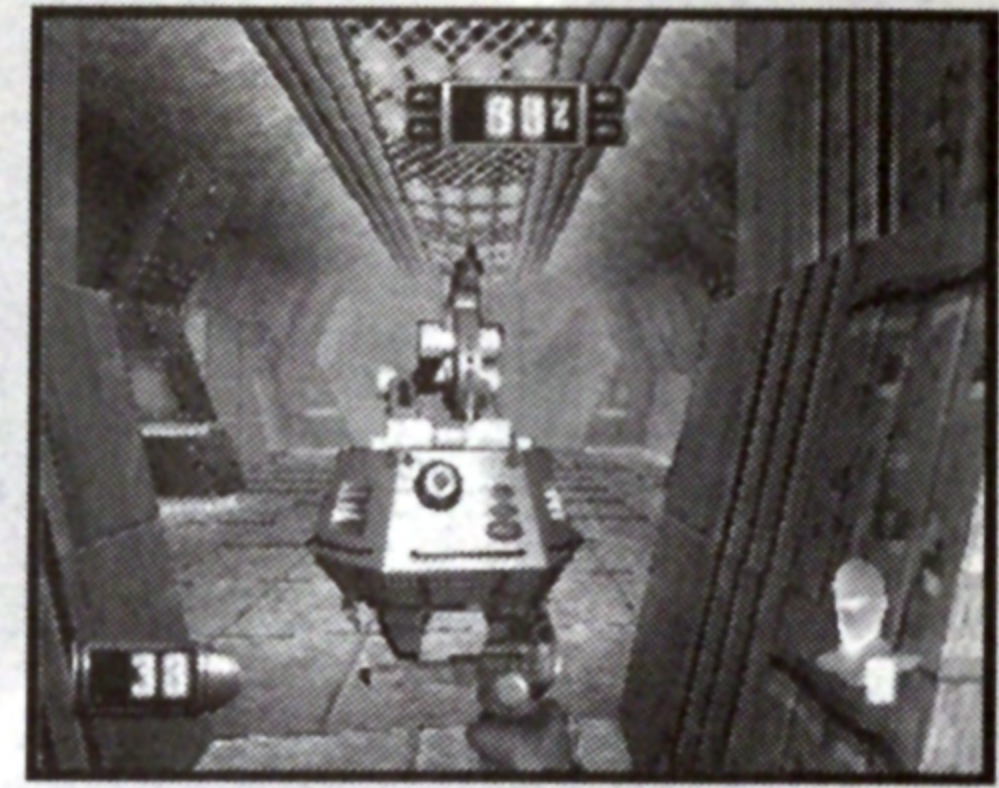

The first eight missions are listed below to give you an idea of what to expect. The remainder of the missions you will have to encounter on your own, through determination, intuitive skills and raw guts. We hope you make the LightStormers proud to include you in their legendary Corps.

Mission 1 - The Gauntlet

This scenario takes place within a training grid on the grounds of the LightStormer Academy. Just try to make it through in one piece.

NOTE: There are no psionics available on this mission.

Mission 2 - Chemical Factory

The remnants of "Better Living Through Chemicals" are scattered across this desolate wasteland. Avoid falling in the murky pools (acid burns quickly) and use the Phase Rifle as much as possible.

NOTE: The fine art of jumping is best learned on this mission. This is also your first opportunity to practice psionics.



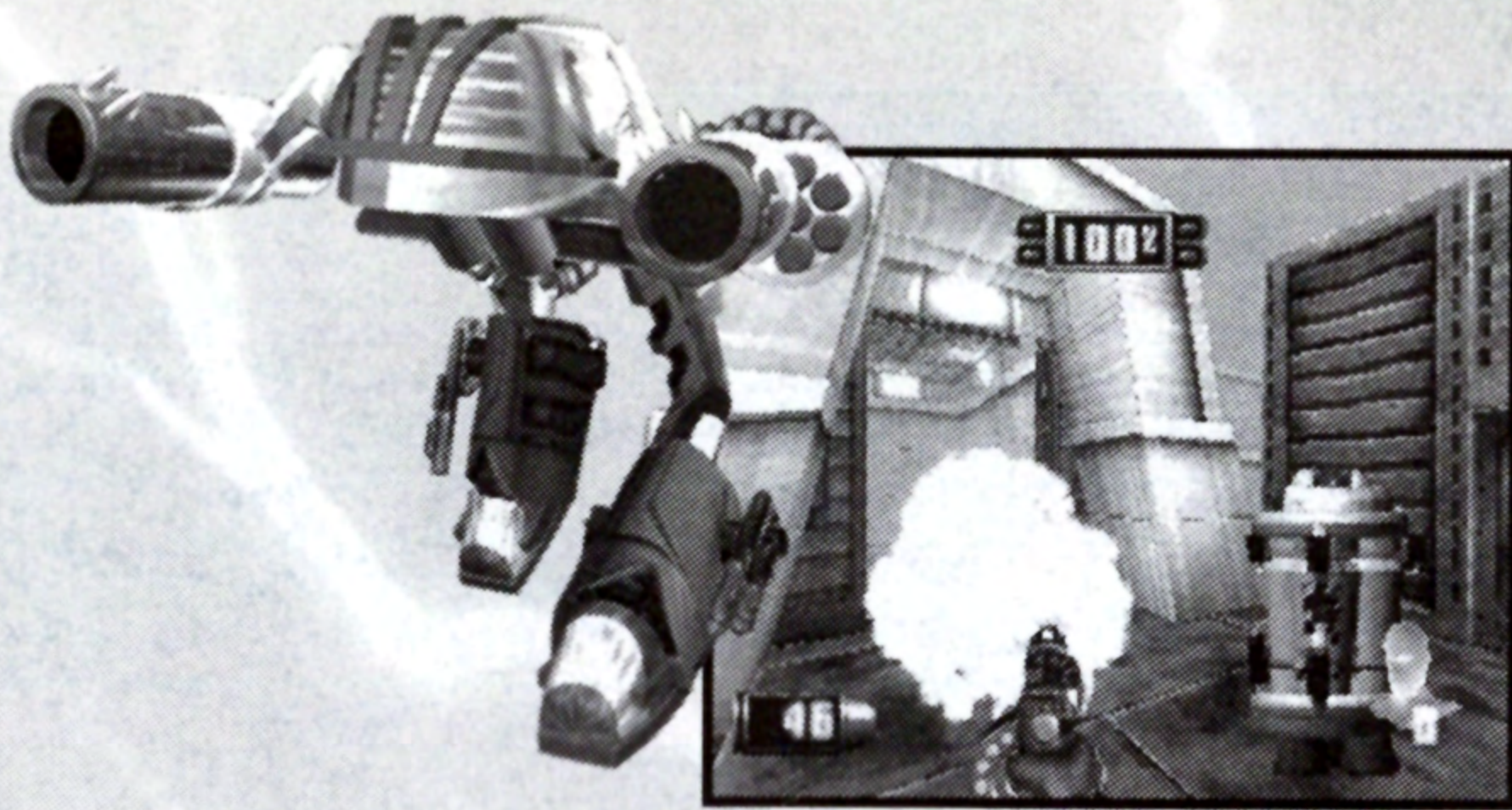

Mission 3 - Rooftop Terrorist Elimination

Last of the training exercises, this mission involves you in the gentle art of robot rearrangement. You simply replace the finely-crafted Terrorist Droid's moving parts with as much raw firepower within your sphere of control as you can.

NOTE: Do not shoot the hostage droids! Not only is shooting the hostage droids bad form, but you'll soon learn there's a reason they look like floating tanks of liquid explosive...

Mission 4 - Jupiter Station Destruction

It's now all for real. No more exercises. Your first true mission as a LightStormer sends you to a Cryopirate space station that has parked over the planet Jupiter. Your objective is to infiltrate their station and knock out their anti-gravity engines by destroying three control consoles on board. Between you and the consoles are enough Guard Droids and Cryopirates to keep a platoon of LightStormers busy, let alone a rookie on his first mission.

NOTE: The "AM" in AM Blaster stands for Anti Matter. Just thought you might want to know what you're playing with here.

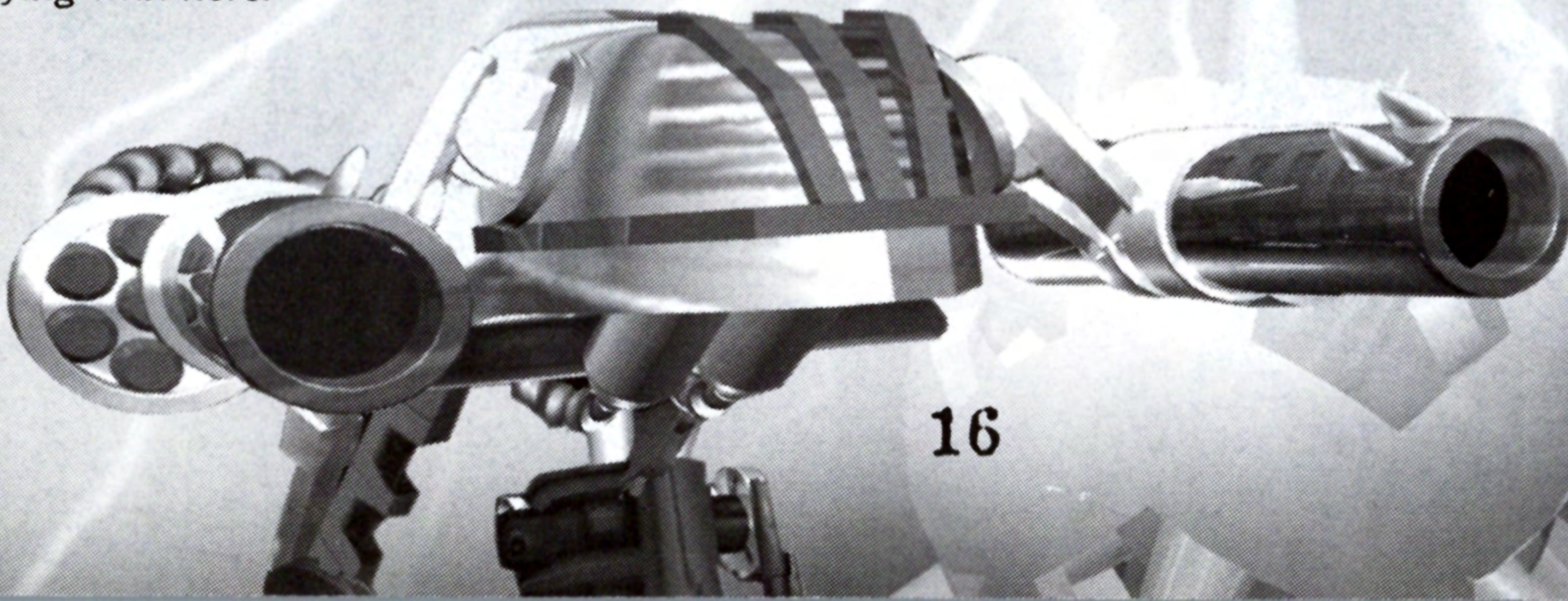

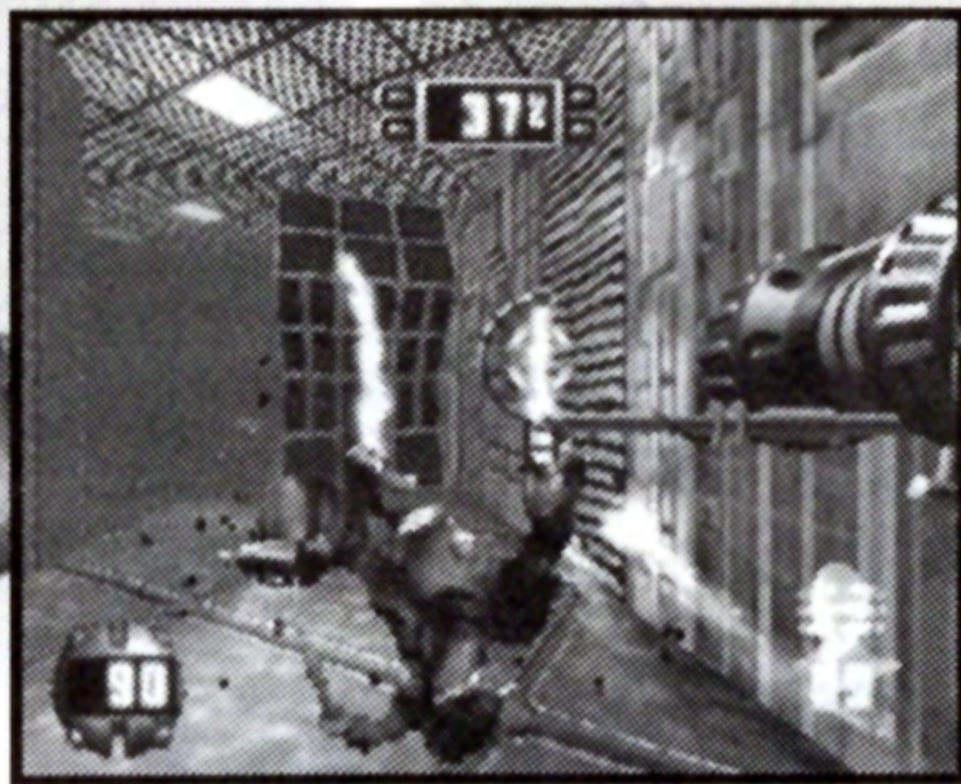

Mission 5 - Terraformer on Triton

A colony of terraformers has been suddenly and mysteriously wiped out. You are sent to determine the nature of the assault and deal with the intruders in the typical LightStormer fashion.

NOTE: Look for the Lock-On Cannon in this mission. It is currently owned and operated by a very big and unfriendly creature.

Mission 6 - Alien Ruins on Mars

There is real life on Mars! Unfortunately, it has killed all the scientists sent to study it. This alien ruin is buzzing with so much psionic energy, your metallic weapons can't get beamed down with you. Fortunately, you've got the Blast psionic, and that psionic energy should work to your advantage. Your job is to find a mysterious psionic 'orb.' Try not to fail as others have before you.

NOTE: Although the scientists were lightly armed, their guns won't be nearly enough to get through. Better use those psionics...

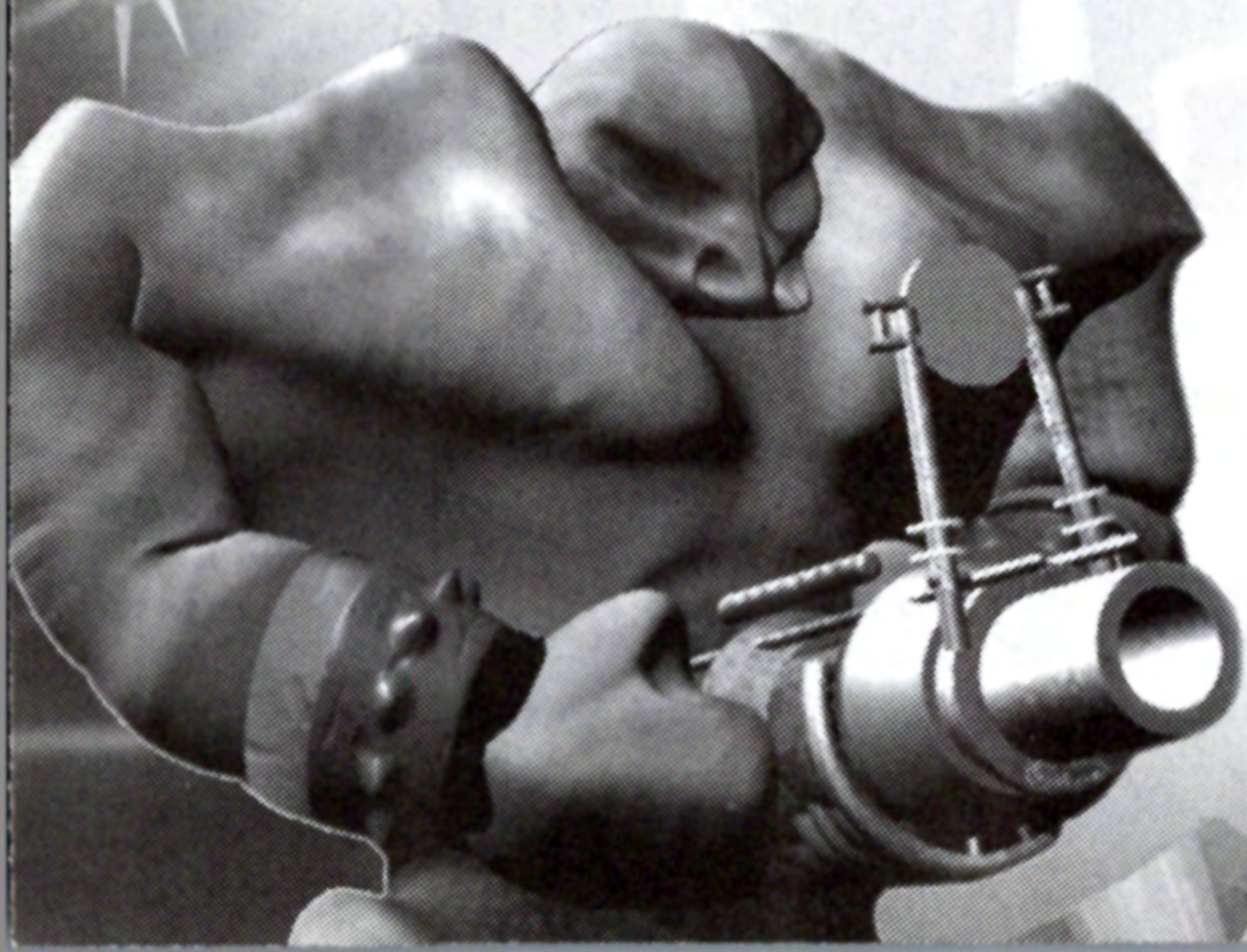

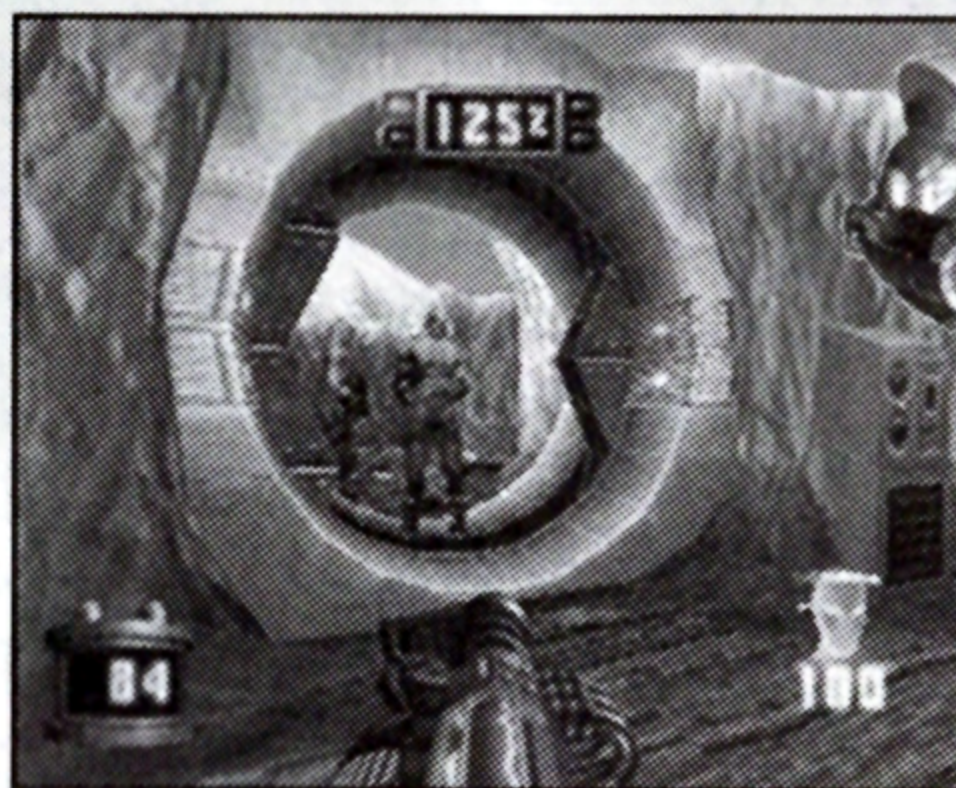

Mission 7 - Biowarfare Lab in Antarctica

How did the mutants from off-world end up on Earth? What are they doing in a secret base at the bottom of the planet? Your mission is to find answers to these questions and locate the mutants' genetic databank. That is if you want to avoid becoming another corpsicle.

Mission 8 - Sulphurine Mines of Io

Welcome to one of the most desolate places in explored space. Io has been an abundant energy source for civilization for decades but now it is threatened by a terrorist takeover. The good news is your chief opponents on this mission are humans. The bad news is they are almost as deadly in the art of combat as you are (and there's a whole bunch more of them than you).

NOTE: Sulphurine lava is detrimental to your health.



Gameplay Notes and Passwords

Keep track of your progress and earned passwords here. Do not let this journal fall into the hands of rookie LightStormers! Let them earn their reputation by acts of heroism, not stealth.

Visit The Disruptor Web Site at www.disruptor.com!

The phone number for our customer service is (818)866-2812

Credits

Created by

Insomniac Games:

Ted Price
Craig Stitt
Travis Price
David Ehlers
Martin Bruinsma

Programming by:

Alex Hastings
Brian Hastings

In Association With Universal Interactive Studios:

Rob Biniarz
Mark Cerny
Kelly Flaherty
Michael John

Production Design by:

Catherine Hardwicke

Conceptual Design by:

Stephen Alesch
Luis Hoyos

Music by:

David Bergeaud

Sound Effects by:

Universal Sound Editing
Ron Horwitz
Kevin Spears
Rich Cusano

In-Game Voice by:

Tami Heide

Quality Assurance by:

Craig Perkins
Michael Alphonzo
Joe Labbe
Steve Rosenthal

Additional Programming by:

John Brooks

Additional Artwork by:

Mark Glaser
Dallas Good
Kieron Lo

Additional Character Designs by:

Brandon Humphries
Barry Pringle
Willis Wong

DISRUPTOR MOVIE:

Don Jeffcoat as Jack Curtis
Vaughn Armstrong as
President Krieger
Christine Champion as Eve
Anthony Palermo as Blake Curtis
Trae Thomas as Troy Alexander

MCA Television Entertainment

Barbara Fisher
Randy Levinson
Angela Mancuso

Producer:

Michael Joyce

Director:

Adam Weissman

Associate Producer:

Judy Marlin

Screenplay by:

Peter Hankoff

Story Consultation by:

Carl Cramer
Ken Selden

Director of Photography:

Kenneth Stipe

Production Designer:

Curtis Schnell

Editor:

Terry Stokes

CGI Effects:

Foundation Imaging

Property Master:

Brad Breitbarth

Gaffer:

Bill Marley

Key Grip:

David Winner

Re-Recording Mixer:

Peter Reale

Special Thanks to:

Nick Earl
Roxanne Lippel
Donna Smith & Don Zepfel
Moore & Price Design Group

Limited Warranty

Universal Interactive Studios, Inc. warrants to the original purchaser of this software product that the medium on which this computer program is recorded is free from defects in materials and workmanship for a period of ninety (90) days from the date of purchase. This Universal Interactive Studios, Inc. program is sold "as is," without express or implied warranty of any kind, and Universal Interactive Studios, Inc. is not liable for any losses or damages of any kind resulting from the use of this program. Universal Interactive Studios, Inc. agrees for a period of ninety (90) days to replace, free of charge, any Universal Interactive Studios, Inc. software product, postage paid, with proof of purchase, at the Universal Interactive Studios, Inc. Warranty Department. This warranty is not applicable to normal wear and tear. This warranty shall not be applicable and shall be void if the defect in this software product has arisen through abuse, unreasonable use, mistreatment or neglect.

LIMITATIONS

THIS WARRANTY IS IN LIEU OF ALL OTHER WARRANTIES AND NO OTHER REPRESENTATION OR CLAIMS OF ANY NATURE SHALL BE BINDING ON OR OBLIGATE UNIVERSAL INTERACTIVE STUDIOS, INC. ANY IMPLIED WARRANTIES APPLICABLE TO THIS SOFTWARE PRODUCT, INCLUDING WARRANTIES OF MERCHANTABILITY AND FITNESS FOR A PARTICULAR PURPOSE, ARE LIMITED TO THE NINETY (90) DAY PERIOD DESCRIBED ABOVE. IN NO EVENT WILL THE ABOVE MENTIONED COMPANIES BE LIABLE FOR ANY SPECIAL, INCIDENTAL, OR CONSEQUENTIAL DAMAGES RESULTING FROM POSSESSION, USE, OR MALFUNCTION OF THIS PRODUCT. SOME STATES DO NOT ALLOW LIMITATIONS AS TO HOW LONG AN IMPLIED WARRANTY LASTS AND/OR EXCLUSIONS OR LIMITATIONS OF INCIDENTAL OR CONSEQUENTIAL DAMAGES SO THE ABOVE LIMITATIONS AND/OR EXCLUSIONS MAY NOT APPLY TO YOU. THIS WARRANTY GIVES YOU SPECIFIC RIGHTS, AND YOU MAY HAVE OTHER RIGHTS WHICH VARY FROM STATE TO STATE.

RETURNS AFTER WARRANTY

To replace defective media after the ninety (90) day warranty period has expired, send the original compact disc (without packaging) to the Universal Interactive Studios, Inc. address below. Enclose a statement of the defect, your name, your return address, and a check or money order for \$5.00 (made payable to MCA INC.) to cover postage and handling.

Universal Interactive Studios, Inc.
Attn: Warranty Department
100 Universal City Plaza
Universal City, CA 91608

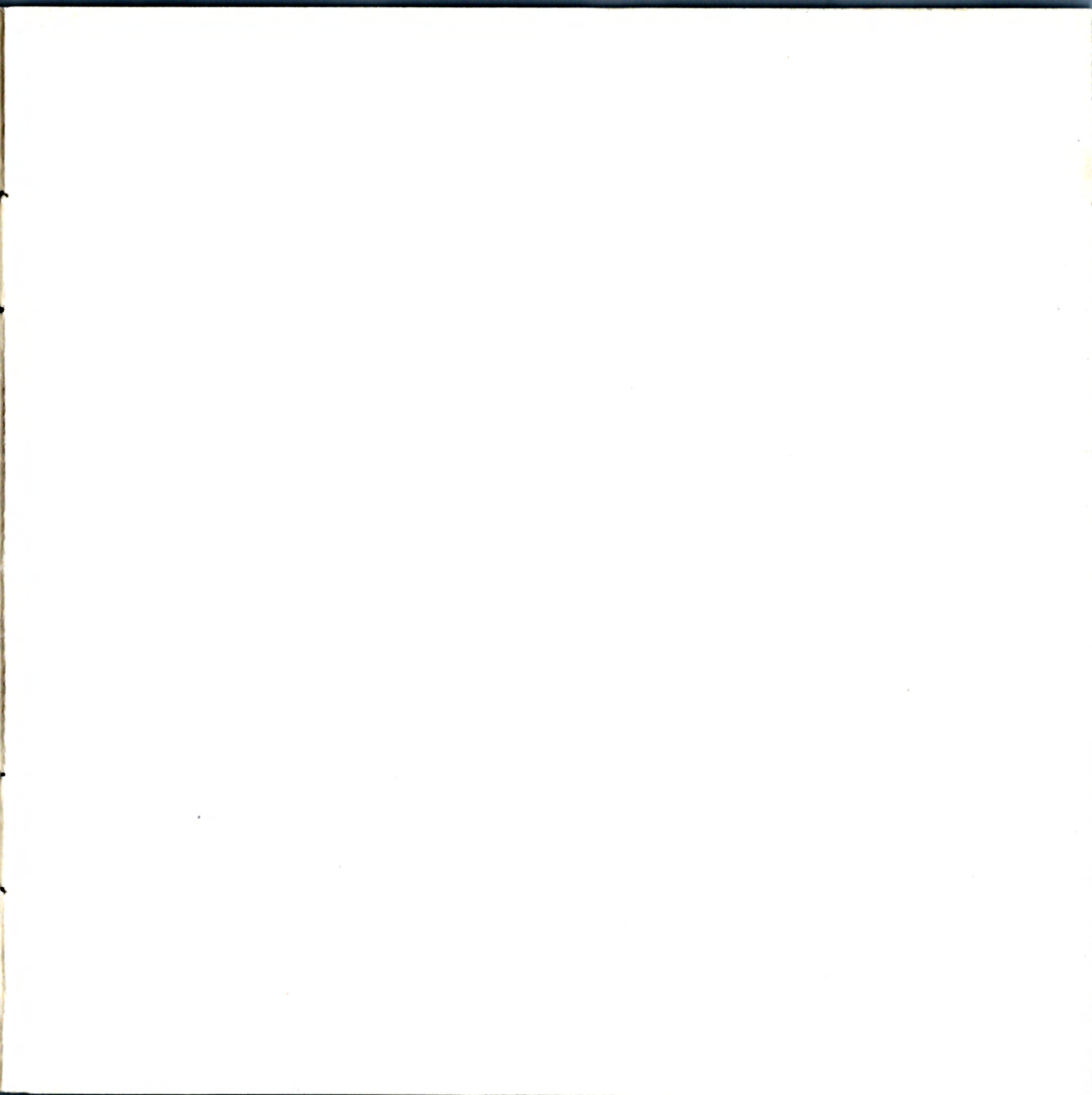

Universal Interactive Studios, 100 Universal City Plaza, Universal City, CA 91608
© 1996 UNIVERSAL INTERACTIVE STUDIOS, INC. SOURCE CODE: ©1996 INSOMNIAC GAMES, INC.
DISRUPTOR IS A TRADEMARK OF UNIVERSAL INTERACTIVE STUDIOS, INC.



PlayStation

Licensed by Sony Computer Entertainment America for use with the PlayStation game console. PlayStation and the PlayStation logos are trademarks of Sony Computer Entertainment Inc. The ratings icon is a trademark of the Interactive Digital Software Association. Manufactured and printed in the U.S.A. THIS SOFTWARE IS COMPATIBLE WITH PLAYSTATION GAME CONSOLES WITH THE NTSC U/C DESIGNATION. U.S. AND FOREIGN PATENTS PENDING.